

Kotron® Sentinel

Models 822, 832 and 842

Software Ver. 2.0D Integral Mount
Software Ver. 2.0C Remote Mount

Installation and Operating Manual



RF

Capacitance

Point

Level

Switches

Read this Manual Before Installing

This manual provides information on the Kotron Models 822, 832 and 842 RF Point Level Switches. It is important that all instructions are read carefully and followed in sequence.

Conventions Used in this Manual

Certain conventions are used in this manual to convey specific types of information. General technical material, support data, and safety information are presented in narrative form. The following styles are used for notes, cautions, and warnings.

NOTES

Notes contain information that augments or clarifies an operating step. Notes do not normally contain actions. They follow the procedural steps to which they refer.

Cautions

Cautions alert the technician to special conditions that could injure personnel, damage equipment, or reduce a component's mechanical integrity. Cautions are also used to alert the technician to unsafe practices or the need for special protective equipment or specific materials. In this manual, a caution box indicates a potentially hazardous situation which, if not avoided, may result in minor or moderate injury.

WARNINGS

Warnings identify potentially dangerous situations or serious hazards. In this manual, a warning indicates an imminently hazardous situation which, if not avoided, could result in serious injury or death.

Safety Messages

The Kotron Model 822, 832 and 842 systems may be properly installed in Category II, Pollution Degree 2 installations. Follow all standard industry procedures for servicing electrical and computer equipment when working with or around high voltage. Always shut off the power supply before touching any components. Although high voltage is not present in this system, it may be present in other systems.

Electrical components are sensitive to electrostatic discharge. To prevent equipment damage, observe safety procedures when working with electrostatic sensitive components.

WARNING! Explosion hazard. Do not connect or disconnect equipment unless power has been switched off or the area is known to be non-hazardous.

Low Voltage Directive

For use in Category II installations. If equipment is used in a manner not specified by manufacturer, protection provided by equipment may be impaired.

Notice of Trademark, Copyright, and Limitations

Magnetrol & Magnetrol logotype, STI & STI logotype, and Kotron are registered trademarks of Magnetrol International.

Copyright © 2006 Magnetrol International
All rights reserved.

Performance specifications are effective with date of issue and are subject to change without notice. Magnetrol reserves the right to make changes to the product described in this manual at any time without notice. Magnetrol makes no warranty with respect to the accuracy of the information in this manual.

Warranty

All Magnetrol/STI electronic level and flow controls are warranted free of defects in materials or workmanship for one full year from the date of original factory shipment.

If returned within the warranty period; and, upon factory inspection of the control, the cause of the claim is determined to be covered under the warranty; then, Magnetrol/STI will repair or replace the control at no cost to the purchaser (or owner) other than transportation.

Magnetrol/STI shall not be liable for misapplication, labor claims, direct or consequential damage or expense arising from the installation or use of equipment. There are no other warranties expressed or implied, except special written warranties covering some Magnetrol/STI products.

Quality Assurance

The quality assurance system in place at Magnetrol/STI guarantees the highest level of quality throughout the company. Magnetrol/STI is committed to providing full customer satisfaction both in quality products and quality service.

Magnetrol's quality assurance system is registered to ISO 9001 affirming its commitment to known international quality standards providing the strongest assurance of product/service quality available.



Kotron Sentinel Models 822, 832 and 842 RF Point Level Switches

Table of Contents

1.0 Complete Installation	
1.1 Unpacking	1
1.2 Electrostatic Discharge (ESD) Handling Procedure...	1
1.3 Before You Begin	2
1.3.1 Site Preparation	2
1.3.2 Equipment and Tools.....	2
1.3.3 Operational Considerations	2
1.4 Mounting	3
1.4.1 Horizontal Mounting	4
1.4.2 Vertical Mounting.....	4
1.5 Probe Installation	5
1.5.1 Installing a Standard Probe	5
1.5.2 Installing a Flexible Probe.....	5
1.6 Installing a Remote Unit	7
1.6.1 Main Amplifier	7
1.6.2 Preamplifier	7
1.6.3 Remote Wiring Connections	7
1.7 Wiring	8
1.7.1 Relay Wiring	8
1.7.2 Power Wiring	8
1.7.3 Relay Wiring Chart	9
2.0 Calibration	
2.1 Operator Set Up.....	10
2.2 Program Paths	11
2.3 Calibration – Single Point	12
2.3.1 Program Path 1 – Configuration	12
2.3.2 Program Path 2 – Single Point	13
2.4 Calibration – Multi Point.....	16
2.4.1 Program Path 1 – Configuration	16
2.4.2 Program Path 3 – Probe Calibration.....	17
2.4.2.1 Probe Calibration Tips.....	18
2.4.2.2 Error Messages in PRLO/HI Menus.....	19
2.4.3 Program Path 4 – Multi-Point.....	20
2.4.4 Program Path 5 – Service	22
2.5 Advanced Calibration	24
2.5.1 Calibration with No Level Change	24
2.5.2 Tank Commissioning	24
2.5.2.1 Single Point	24
2.5.2.2 Multi-Point.....	24
3.0 Reference Information	25
3.1 Troubleshooting.....	25
3.1.1 Error Message Codes	25
3.2 Specifications.....	26
3.2.1 Electrical	26
3.3 Agency Approvals	27
3.4 Intrinsic Safety.....	28
3.5 Specifications.....	30
3.5.1 Dimensional.....	30
3.6 Parts	33
3.6.1 Replacement	33
3.7 Model Numbers	34

1.0 Complete Installation

This section provides detailed procedures for properly installing, configuring, and, as needed, troubleshooting Kotron Model 822, 832 and 842 Sentinel Point Level Switches.

1.1 Unpacking

Unpack the instrument carefully. Make sure all components have been removed from the packing material. Check all the contents against the packing slip and report any discrepancies to the factory.

Before proceeding with the installation, do the following:

- Inspect all components for damage. Report any damage to the carrier within 24 hours.
- Make sure the nameplate model number agrees with the packing slip and purchase order.
- Record the model and serial numbers for future reference when ordering parts.

1.2 Electrostatic Discharge (ESD) Handling Procedure

Magnetrol's electronic instruments are manufactured to the highest quality standards. These instruments use electronic components that may be damaged by static electricity present in most work environments.

The following steps are recommended to reduce the risk of component failure due to electrostatic discharge.

- Ship and store circuit boards in anti-static bags. If an anti-static bag is not available, wrap the board in aluminum foil. Do not place boards on foam packing materials.
- Use a grounding wrist strap when installing and removing circuit boards. A grounded workstation is recommended.
- Handle circuit boards only by the edges. Do not touch components or connector pins.
- Make sure that all electrical connections are completely made and none are partial or floating. Ground all equipment to a good, earth ground.

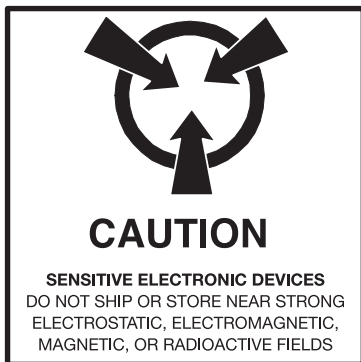

1.3 Before You Begin

1.3.1 Site Preparation

Each Kotron Model 822, 832 and 842 switch is built to match the specific physical specifications of the required installation. Make sure the probe connection is correct for the threaded or flanged mounting on the vessel or tank where the switch will be placed. See *Section 1.4, Mounting*.

Make sure that the wiring between the power supply and the Model 822, 832 or 842 switch is complete and correct for the type of installation. See *Section 3.2, Specifications*.

When installing the Model 822, 832 or 842 switch in a general purpose or hazardous area, all local, state, and federal regulations and guidelines must be observed. See *Section 1.7, Wiring*.

1.3.2 Equipment and Tools

No special equipment or tools are required to install the Model 822, 832 or 842 switch. The following items are recommended:

- 1 $\frac{1}{8}$ " open-end wrench or adjustable wrench to fit the probe process connection size and type.
- Flat-blade screwdriver

1.3.3 Operational Considerations

The Model 822, 832 or 842 switch should be located for easy access for service, configuration, and monitoring. There should be sufficient headroom to allow the probe to be inserted into the tank. Special precautions should be made to prevent exposure to corrosive atmosphere, excessive vibration, shock, or physical damage.

The electronics should not be exposed to ambient temperatures above +160° F (+70° C) or below -40° F (-40° C). The proper operating temperature range for the display is -4° F (-20° C) to +160° F (+70° C). The temperature limits for the probe depend on the style and part number of the specific probe used.

1.4 Mounting

The Model 822, 832 or 842 switch can be mounted to a tank using a variety of process connections. Generally, either a threaded or flanged connection is used. For information about the sizes and types of connections available, see *Probe Brochure 50-125*.

Make sure all mounting connections are properly in place on the tank before installing the probe. Make sure the Kotron probe is correct for the intended installation.

It is common practice to use the metal tank wall as the reference electrode. In such cases, it is required that the probe housing makes a good electrical connection to the tank wall. If there is any doubt about this connection or to the use of PTFE thread tape gaskets, paint, rust, or any other reason, a separate strap should be installed between the probe housing and the tank.

Caution: This unit contains CMOS electronics which may be damaged by static electricity. Do not touch any semiconductor devices unless you are properly grounded.

Caution: When a probe is used in an abrasive medium, inspect the probe periodically for visible surface wear. If damage to the probe insulation is found, replace the probe.

Metal Walled Tanks

On water-based liquids, there should be no problem with sensitivity or linearity. With non-conductive, low dielectric media, sensitivity can be enhanced by locating the probe close to and parallel with the tank wall. If this is not practical, a ground reference probe may be the solution.

Non-Metallic and Glass-Lined Tanks

With plastic, concrete, wood, or any other non-conductive walled vessels a ground reference is required. Most commonly, this electrode will be in the form of a concentric ground tube (i.e., stilling well). In questionable circumstances, consult the factory. In all cases, a good electrical connection must be made between the ground surface and the probe housing.

Switch/Probe Assembly

Switches with probes up to and including 12 inches (300 mm) in length are shipped pre-assembled. All other switches are shipped unassembled to avoid damage during transit. These transmitters must be assembled prior to mounting. Choose your particular configuration from the following sections and follow the instructions carefully.

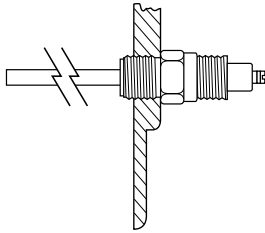

Figure 1

Recommended Horizontal Mounting

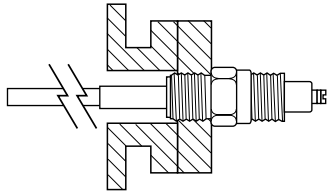

Figure 2

Recommended Mounting with Nozzle

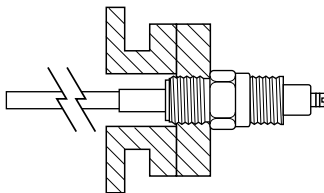

Figure 3

Not recommended

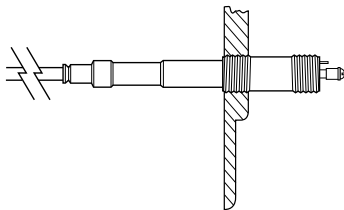

Figure 4

Recommended Horizontal Mounting

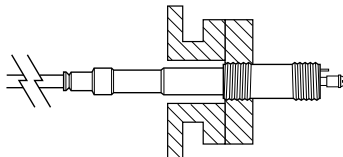

Figure 5

Recommended Horizontal Mounting

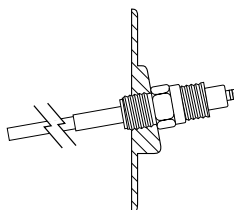

Figure 6

Alternate Horizontal Mounting

1.4.1 Horizontal Mounting **Alarm (narrow differential) applications only**

Horizontally mounted probes provide a high degree of sensitivity for use with non-conductive liquids as only approximately 0.5 inches (12 mm) of level change is required to completely cover (or uncover) the probe.

Horizontally mounted probes should be installed so that the probe is parallel to and at the level at which the control point is desired. Refer to Figure 1.

Avoid any installation method in which the material may become trapped in the mounting nozzle, thus preventing the probe from signaling when the level recedes. Refer to Figures 2 and 3.

NOTE: If nozzle mounting is unavoidable, the probe must be installed with an inactive metal sheath having a length of at least 1 inch (25 mm) greater than length of the nozzle. A sheath is required to render the length of the probe within nozzle insensitive to capacitance change. Refer to Figure 2.

Guarded Probe

Unit will signal at probe level. Refer to Figures 4 and 5.

NOTE: The guard element must be located outside of the nozzle. Do not horizontally mount the unit in a nozzle deeper than 3 inches (75 mm). Refer to Figure 5. The medium may buildup in the nozzle and cause false activation.

Alternate Horizontal Mounting

On applications involving viscous liquids or materials which tend to cling or buildup, horizontally mounted probes should be installed at a slight downward angle to allow material to drain from probe rod. With this type of installation, the packing gland face of probe assembly should extend into the tank (or vessel). Refer to Figure 6.

1.4.2 Vertical Mounting

Vertically mounted probes provide the capability to adjust the control point up or down a section of probe rod by means of calibration adjustments within the unit.

Vertically mounted probes should be installed so that the end of the probe rod is at least 2 inches (50 mm) below the lowest desired level control point with conductive materials or 4 inches (100 mm) below the lowest desired level control point with non-conductive materials. Refer to Figure 7 on page 5.

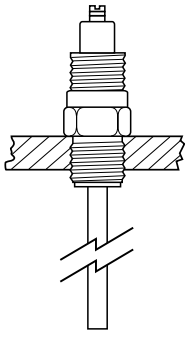

Figure 7
Vertical Mounting

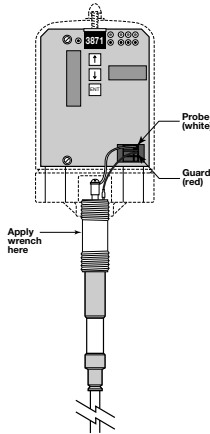

Figure 8
Integral Mount with Guarded Probe

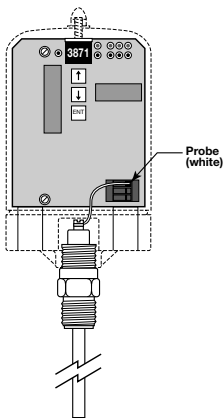

Figure 9
Integral Mount with Standard Rigid Probe

1.5 Probe Installation

NOTE: For units with remote electronics, the probe connections are made to the preamplifier. There is a two wire connection between the preamplifier and the main electronics. Refer to *Section 1.6, Installing a Remote Unit*, for details of installing the remote electronics. Follow *Section 1.5, Probe Installation* directions for details in installing the probe.

1.5.1 Installing a Standard Probe

Before installing, ensure the:

- Probe has adequate headroom for installation and has unobstructed entry in the vessel.
- Process temperature, pressure, dielectric, and viscosity are within the probe specifications for the installation. See *Section 3.2, Specifications*.

To install a probe:

1. Thread probe into mounting bushing on tank.
2. Tighten securely, being certain that the wrench is applied **ONLY** to the mounting gland. Refer to Figure 9.
3. Screw the amplifier housing onto the probe. Refer to Figure 9.
4. Screw housing on the probe until hand tight. Housing can be wrench tightened to align conduit connection with conduit.
5. Locate the white wire which is fastened to the probe terminal (P), Connect the free end of this wire to the probe connection screw.
6. Proceed to *Section 1.7, Wiring*.

1.5.2 Installing a Flexible Probe

Caution: Insulated flexible probes are shipped with the cable clamp and the packing gland nut hand tightened. The end of a flexible probe **MUST** be kept taut by attaching the anchor end at the bottom of the vessel or by using a Magnetrol supplied probe weight.

Caution: Do not discard the Mylar® housing insulator.

Caution: The probe cable must not be in contact with any metallic surface in its final installation position.

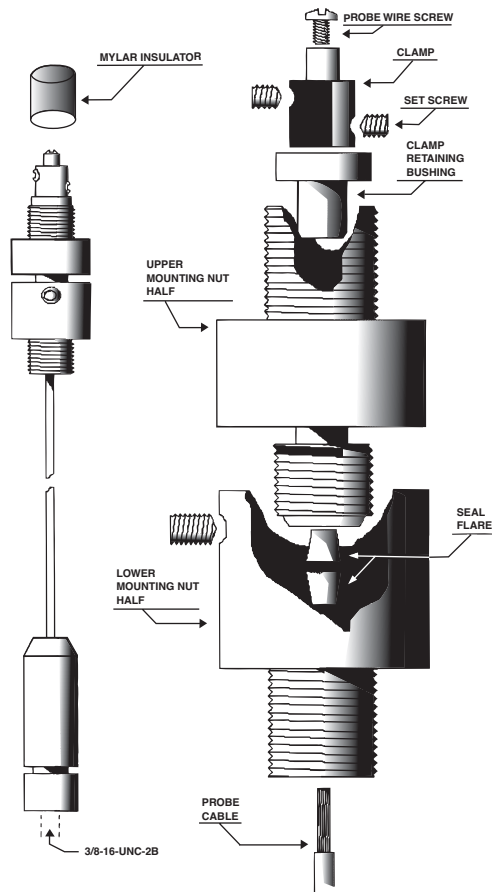

Figure 10
Integral Mount with Flexible Probe

To install a probe:

1. Attach the weight or anchor assembly to the end of the probe. Insert the probe through the vessel's mounting connection, and feed the cable into the vessel. Do not allow the probe to scrape against the connection threads.
2. Secure the anchor assembly (if used), to the bottom of the vessel.
3. Apply thread sealant to the mounting nut. Screw the mounting nut into the mounting connection until tight.
4. Remove the Mylar housing insulator located over the clamp. **DO NOT DISCARD.**
5. Loosen both socket head screws from the clamp. Pull the clamp and Teflon® retaining bushing off of the probe.
6. While holding on to the probe cable, loosen the upper packing gland nut. **DO NOT ALLOW THE PROBE CABLE TO FALL INTO THE VESSEL.**
7. Pull the excess cable up through the packing gland nut until the cable is taut. Tighten the packing gland nut.
8. Cut the cable 1.35" (34 mm) above the packing gland nut and strip off 1.25" (32 mm) of insulation.
9. Slide the Teflon® retaining bushing onto the cable and seat it into the packing gland nut. Slide the clamp onto the cable and seat it against the Teflon® retaining bushing.
10. Tighten both socket head screws, on the clamp, to approximately 35 in/lbs of torque. Slip the Mylar® insulator over the clamp.

Caution: Check probe terminal connection carefully to be certain lug will not short to packing gland or interfere with assembly of amplifier housing to probe.

11. Locate the white wire which is fastened to the probe terminal (P), Connect the free end of this wire to the probe connection screw.
12. Proceed to *Section 1.7, Wiring.*

1.6 Installing a Remote Unit

NOTE: Units with remote electronics are provided with the Main Amplifier and a preamplifier. Probe connections are made to the preamplifier. Refer to *Section 1.5, Probe Installation* for details in installing the probe.

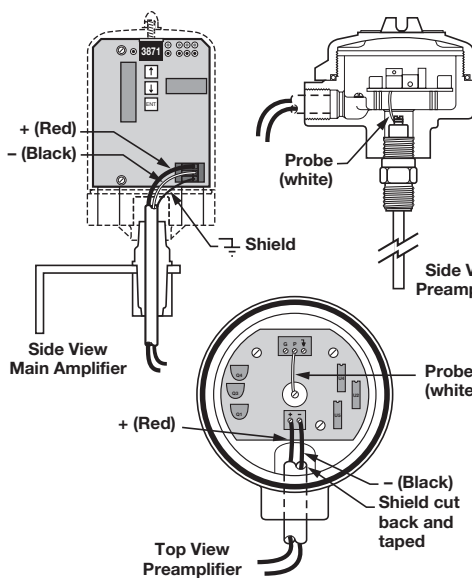

Figure 11
Remote Electronics with
Standard Rigid or Flexible Probe

1.6.1 Main Amplifier

Remote amplifier assemblies are normally shipped from the factory assembled into an “L” mounting bracket. Install bracket in a location that will isolate the unit from temperatures below -40°F (-40°C) and over $+160^{\circ}\text{F}$ ($+70^{\circ}\text{C}$) or vibration/mechanical damage. Unit can be mounted up to 2500 feet (760 m) from probe assembly. Intrinsically safe models can be mounted up to 800 feet (240 m) from probe assembly. Location should also offer easy access for wiring, calibration, and maintenance.

1.6.2 Preamplifier

1. Screw the preamplifier housing onto the probe until hand tight. Housing can be wrench tightened to align conduit connection with conduit.
2. Attach white wire from the probe to the connection on the preamplifier – see Figure 11.
3. If using a guarded probe, attach the red wire from the probe to the connection on preamplifier – see Figure 12.

1.6.3 Remote Wiring Connections

To connect preamplifier-to-amplifier, use shielded, twisted pair, 22-gauge stranded connectors (part number 09-7146-001).

1. Strip approximately 0.4 inch (10 mm) of outer jacket insulation from each end of the shielded, twisted-pair.
2. At the probe preamplifier end, cut the bare shield wire of the cable close to the insulating jacket.
3. Connect the red lead to the positive (+) terminal on the amplifier. Refer to Figure 11 or 12.
4. Connect the black lead to the negative (–) terminal on the preamplifier board.
5. Connect the red lead to positive (+) terminal on the amplifier.
6. Connect black lead to the negative (–) terminal on the amplifier.
7. Connect the shield to the ground ($\overline{\text{T}}$) terminal on the amplifier.

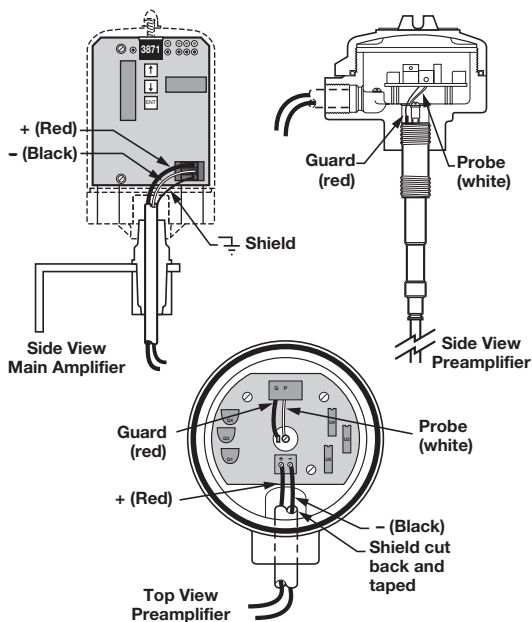

Figure 12
Remote Electronics
with Guarded Probe

1.7 Wiring

WARNING! Explosion hazard. Do not disconnect equipment unless power has been switched off or the area is known to be safe.

1.7.1 Relay Wiring

The recommended connection of power and control circuits is 16 AWG or 18 AWG stranded wire.

To improve external noise immunity, electrical snubbers are provided on the relay contacts. These are factory installed between the common (C) and the normally open (NO) contacts. The position of the snubbers should be changed between the C and NC contacts if the normally closed (NC) contacts are used.

NOTE: If the snubbers are not wired properly in parallel with the relay contacts, external electrical noise may disturb the operation of the instrument.

Refer to *Section 1.7.3, Relay Wiring Chart* for different relay wiring options. Refer to Figure 13 for terminal locations.

NOTES:

1. Relay 2 and relay 3 can be utilized for lead-lag pump sequencing (models 832 and 842 only).
2. Relay 1 can be utilized as a dedicated diagnostic alarm.

Refer to *Calibration* sections (pages 10–23) for proper use of these relays.

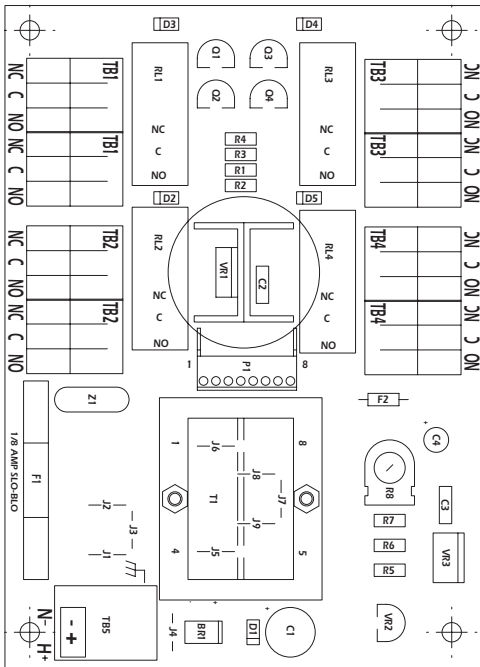

Figure 13

1.7.2 Power Wiring

1. Ensure that power source is turned off.
2. Pull power supply wires through conduit connection.
3. Connect the positive supply wire to the H terminal, and the negative (neutral) supply wire to the N terminal. Connect the ground wire to the green ground screw in the bottom of the housing.
4. Dress the wires together neatly and secure with cable ties. Be certain that adequate clearance exists for replacement of housing cover

NOTE: Observe all applicable electrical codes and proper wiring procedures.

5. Replace housing cover.
6. Apply power to the unit, and proceed with calibration of instrument as described in *Section 2.0, Calibration* beginning on page 10.

NOTE: Be certain to route all power and control wires through conduit outlet only and run probe wire up through center hole in amplifier housing base.

1.7.3 Relay Wiring Chart



Kotron Power	Material Level	Fail-safe	Relay Coil	Relay Terminals	
				CM to NC	CM to NO
On	High	HLFS	De-energized	Closed	Open
		LLFS	Energized	Open	Closed
	Low	HLFS	Energized	Open	Closed
		LLFS	De-energized	Closed	Open
Fail	High	HLFS	De-energized	Closed	Open
		LLFS	De-energized	Closed	Open
	Low	HLFS	De-energized	Closed	Open
		LLFS	De-energized	Closed	Open

NOTES AND DEFINITIONS:

1. Equipment controlled by the Kotron relays is assumed to be powered from one source, while the Kotron unit itself is assumed to be powered from a different source.
2. Fail means a loss of power to the Kotron unit.
3. HLFS (high level fail-safe) means a material level in the tank which is equal to or above:
 - a. The setting of a narrow differential point.
 - b. The higher setting of a wide differential point.
4. LLFS (low level fail-safe) means a material level in the tank which is equal to or below:
 - a. The setting of a narrow differential point.
 - b. The lower setting of a wide differential point.
5.
 - a. When the relay coil is de-energized, a connection is made between terminals C (common) and NC (normally closed), and there is no connection between C and NO (normally open).
 - b. When the relay coil is energized, a connection is made between terminals C and NO, and there is no connection between C and NC.
6. If Relay 1 is being used as a dedicated diagnostic alarm, the relay will always de-energize upon fault detection.



2.0 Calibration

2.1 Operator Set Up



MagneCal™, the Sentinel's sophisticated calibration software, uses a microprocessor-based user interface, which provides the operator unmatched flexibility and programmability for a variety of level control applications. These features are built into the controller and are entered via three tactile-feedback keys (UP  arrow, DOWN  arrow, and ENT ) located on the amplifier circuit board. In addition, a 4-digit LED displays the operating parameters and values. The keys and their functions are shown below.

Upon power up, the LED will display the following message: Magnetrol Int'l followed by a series of walking M's (multi-point) or S's (single point), based on the calibration configuration selected. **This is the normal RUN mode.**



UP/RAISE: Use to scroll up through menu selections, or raise numeric values. There are three speeds for scrolling numeric values. Ramp speed is increased by continuously depressing the UP  arrow key. To decrease speed as the desired value is approached, release the UP  arrow key and unit will revert to the slowest ramp speed.



DOWN/LOWER: Use to scroll down through menu selections or lower numeric values. There are three speeds for scrolling numeric values. Ramp speed is increased by continuously depressing the DOWN  arrow key. To decrease speed as the desired value is approached, release the DOWN  arrow key and the unit will revert to slowest ramp speed.



ENTER: Use to select displayed value and to continue to the next menu selection. Complete menu layouts are provided to show the user-selectable parameters.

NOTE: The unit will automatically time out and revert to the RUN mode after 60 seconds of no key strokes. Any information already entered is secure, and the calibration may be safely resumed at any time.

The microprocessor-based Sentinel offers all operator functions and setup procedures from the three tactile-feedback keys described above. Due to the number of user program-mable features included in the unit, the calibration flow chart is extensive. The flow chart is modular, however, it can be divided into five subsections or program paths which are connected to a home base, or normal operating mode, RUN (walking M or S). When letters scroll horizontally across the LED and no error messages are displayed, all systems are functioning properly. The calibration flow chart structure is shown on page 12.

NOTE: If MagneCal precalibration data was entered at the factory, use Advanced Calibration procedures (Section 2.5) in conjunction with the standard calibration procedures.

2.2 Program Paths

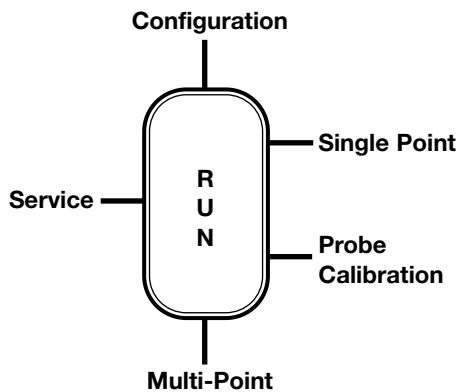

In order to properly calibrate the Sentinel, the Calibration instructions are broken down into the five PATHS described below.

Access to program paths is granted with the following key strokes:

Configuration

Press ENT  and UP  arrow keys simultaneously ( )

Single Point

Press ENT 

Probe Calibration

Press UP  and DOWN  arrow keys simultaneously ( )







NOTE: This procedure MUST be performed if Multi-Point mode is selected.

Multi-Point

Press ENT 

Service

Press ENT  and DOWN  arrow keys simultaneously ( )

NOTE: At any given time during user configuration, pressing the ENT , UP , and DOWN  arrow keys simultaneously (  ) will escape from any location and return to RUN.

2.3 Calibration—Single Point

2.3.1 Program Path 1 — Configuration

The SING (single point) program is for single point alarm applications and allows for proper calibration without level change. The MULT (multi-point) program is for all pump (wide differential) control, multiple relay applications, and single point applications where an adjustable set point is needed.

NOTE: Specific order of the configuration modes must be followed for proper calibration of the Sentinel Level Switch. It is imperative that the user select CONFIGURATION for the first calibration procedure. Within the CONFIGURATION mode, the single or multi-point operation must be selected. This selection affects the balance of the configuration procedures and will significantly affect the performance of the level switch if the modes of operation are not followed.

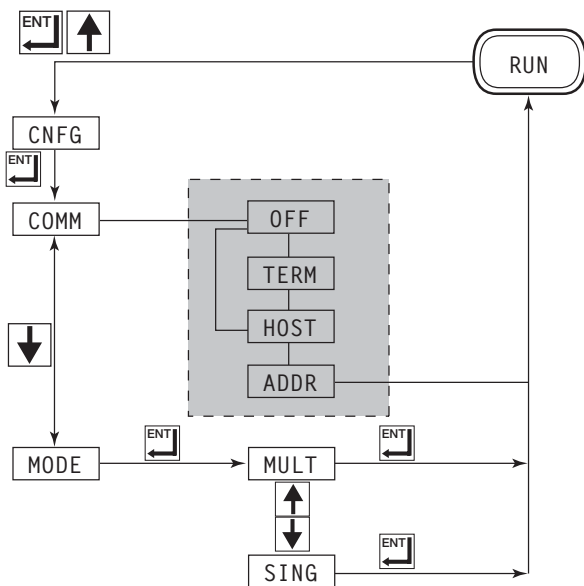

Calibration Flow Structure

STEP 1: CNFG (Configuration)

1. From the RUN mode, press the ENT and the UP arrow key simultaneously (ENT) to enter the menu. The display will read CNFG. Configuration is the first mode in configuring the Sentinel. (Refer to the previous NOTE).
2. Press ENT to confirm configuration selection and unit will display COMM. COMM (Communications) refers to a future RS-485 option of the Sentinel. Although selections appear in the flowchart (screened area) and in the software program, these features are not available at this time.
3. With COMM displayed, press DOWN to display MODE.

STEP 2: MODE (Mode)

1. Mode refers to the selection of a single point (alarm only) or multi-point a (pump control) application of the Sentinel. Press ENT to display MULT.
2. Since single point use is desired, using the UP or DOWN arrow keys, toggle between single or multi-point selection.
3. Once SING is displayed, press ENT to return to the RUN mode.

NOTE: Upon SING (single point) selection and the return to the RUN mode, the display will verify your selection by displaying a walking S (single point mode). Proceed to *Section 2.3.2, Program Path 2 — Single Point*.



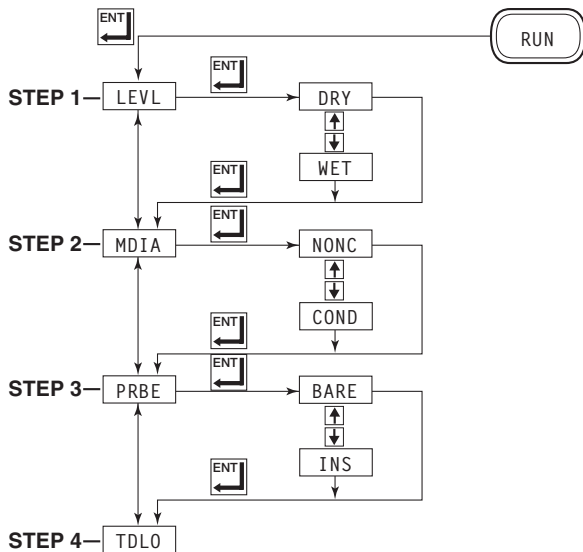

2.3.2 Program Path 2 — Single Point

The single point program is for single point, alarm only applications and allows for proper calibration *without* level change. The following procedures must be followed if SING (single point) has been selected in Program Path 1 CNFG (configuration). When in need of an adjustable set point (vertical probe only), use MULT (multi-point).





From the RUN display, press ENT .



STEP 1: LEVL (Level)

1. From the RUN mode, press the ENT  key to enter this menu. The display will read LEVL. LEVL refers to the condition of the probe DRY (not covered with media) or WET (covered with media).
2. Press ENT  to display DRY.
3. Using the UP  and DOWN  arrow keys, toggle between DRY and WET until the display reads the current condition of the probe.
4. Press ENT  to store this value. The display will read MDIA.



STEP 2: MDIA (Media)



1. MDIA (media) refers to the conductance n(dielectric) of the process media. Press ENT  to display NONC (non-conductive).
2. Using the UP  and DOWN  arrow keys, toggle between NONC (non-conductive) and COND (conductive) until the display reads the appropriate condition of the media.
3. Press ENT  to store this value. The display reads PRBE.

NOTES:

1. This procedure sets the sensitivity appropriate for the application: NONC = 0.5 pF COND = 10 pF.
2. If the conductance of the medium is unknown, choose NONC (non-conductive) for greatest sensitivity.
3. When calibrating for media in non-metallic (ungrounded) vessels, choose NONC (non-conductive). This will establish the highest sensitivity (0.5 pF).





STEP 3: PRBE (Probe)

1. PRBE (probe) selects either an insulated or bare probe. When PRBE is displayed, press ENT  to display BARE.
2. If this is the type of probe in use, press ENT . Step 4, TDLO will be displayed.





3. If not, using the UP  and DOWN  arrow keys, toggle between the INS (insulated) and the BARE (bare) probe selections.
4. When the appropriate selection is displayed, press ENT  to store the value and to display TDLO.

NOTE: Choice of MDIA/COND and PRBE/BARE disarms the shorted probe diagnostic check.





STEP 4: TDLO (Time Delay Low)

1. TDLO (time delay low) selects the desired setting of time delay on falling level. When TDLO is displayed, press ENT  to display current value.
2. Using the UP  or DOWN  push-buttons, scroll up or down to achieve the desired numeric value of the time delay low. Time delay is adjustable between 0 and 90 seconds (one second is recommended).
3. When the appropriate value is displayed, press ENT  to store the value and to display TDHI.

STEP 5: TDHI (Time Delay High)

1. TDHI (time delay high) selects the desired setting of time delay on rising level. When TDHI is displayed, press ENT  to display current value.
2. Using the UP  or DOWN  arrow keys, scroll up or down to achieve the desired numeric value of the time delay high. Time delay is adjustable between 0 and 90 seconds (one second is recommended).
3. When the appropriate value is displayed, press ENT  to store the value and to display FLSF.

STEP 6: FLSF (Fail-safe)

1. FLSF (fail-safe) selects either a low level or high level fail-safe condition (relay is energized when not in alarm and de-energized when alarmed). When FLSF is displayed, press ENT  to display LLFS.
2. If this is the desired condition, press ENT  and FALT will be displayed.
3. If HLFS is desired, use the UP  or DOWN  arrow keys to toggle between the selections.
4. When the appropriate selection is displayed, press ENT  to store the value and display FALT.

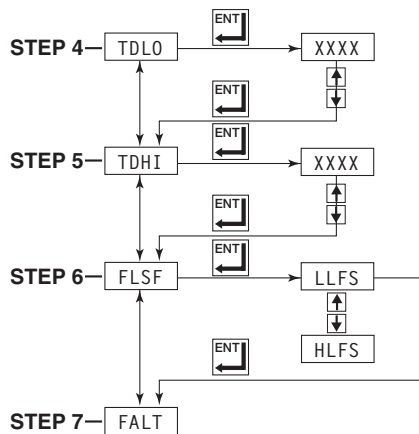





STEP 7: FALT (Fault)





1. FALT (fault) refers to the choice of the alarm relay to DNRG (de-energize) or IGNR (ignore) upon diagnosing a fault.

NOTE: The dedicated diagnostic Relay 1 will always de-energize when a fault is detected.

When FALT is displayed, press ENT  to display DNRG.

2. If this is the desired condition, press ENT  to display CAL.
3. If IGNR is desired, use the UP  or DOWN  arrow key to toggle between the selections.
4. When the appropriate selection is displayed, press ENT  to lock in the value and display CAL.

STEP 8: CAL (Calibration)

1. After modifying any or all of the preceding values, CAL will lock in all the values and store them in memory. Press ENT  to display NO (do not calibrate).
2. Press ENT  if it is desired to leave current values.
3. If new values are desired, use the UP  and DOWN  arrow keys to toggle to YES (calibrate).
4. Press ENT  to lock all the new values in memory and return to the RUN mode.

NOTE: Ensure that the level of the process media is at the exact point that corresponds to the choice made in Step 1 LEVL:DRY (not covered with media) or WET (covered with media). This is critical to the proper calibration of the instrument. The unit will take a new capacitance reading (establish a new set point) when YES is chosen and ENT  is depressed.

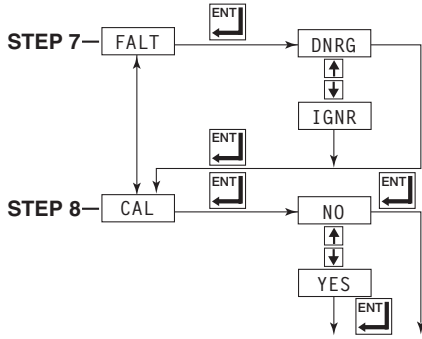

2.4 Calibration—Multi Point





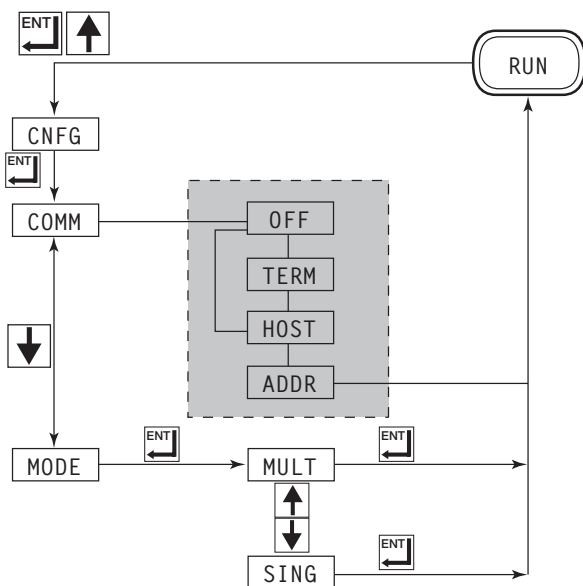

2.4.1 Program Path 1 — Configuration

The SING (single point) program is for single point alarm applications and allows for proper calibration without level change. The MULT (multi-point) program is for all pump (wide differential) control, multiple relay applications, and single point applications where an adjustable set point is needed.



NOTE: Specific order of the configuration modes must be followed for proper calibration of the Sentinel Level Switch. It is imperative that the user select CNFG for the first calibration procedure. Within the CNFG mode, the single or multi-point operation must be selected. This selection affects the balance of the configuration procedures and will significantly affect the performance of the level switch if the modes of operation are not followed.



STEP 1: CNFG (Configuration)

1. From the RUN mode, press the ENT  and the UP  arrow keys simultaneously (ENT  ) to enter the menu. The display will read CNFG. Configuration is the first mode in configuring the Sentinel. (Refer to the NOTE above).
2. Press ENT  to confirm configuration selection and unit will display COMM. COMM (Communications) refers to a future RS-485 option of the Sentinel. Although selections appear in the flowchart (screened area of diagram at left) and in the software program, these features are not available at this time.
3. With COMM displayed, press the DOWN  arrow key to display MODE.

STEP 2: MODE (Mode)

1. MODE refers to the selection of a single point (alarm only) or multi-point application of the Sentinel. Press ENT  to display MULT.
2. Since multi-point use is desired, press ENT  to return to the RUN mode.

For MULT (multi-point) selection, the display will read ****NOT READY****. Proceed to *Section 2.4.2, Program Path 3 — Probe Calibration*.

NOTE: Although standard procedure is to calibrate the probe first (eliminating the ****NOT READY**** message), relay parameters can be set prior to calibrating the probe. This means full calibration of all relays may be done indoors on a test bench. The remaining PRLO/PRHI points can then be calibrated, after the unit is installed.

2.4.2 Program Path 3 — Probe Calibration

NOTES:

1. The media level must be moved to accomplish this procedure. The PRL0 and PRHI points may be entered in any order; they can easily be changed in the future when the process level is at a much higher or lower point.
2. The unit will automatically time out and revert to the RUN mode after 60 seconds without a keystroke; any information already entered remains in memory. To enter any remaining data, simply re-enter the Probe Calibration section.
3. A minimum level change of 2% or 5pF, whichever is greater, of tank height will yield a valid calibration. However, a greater level change yields better accuracy.

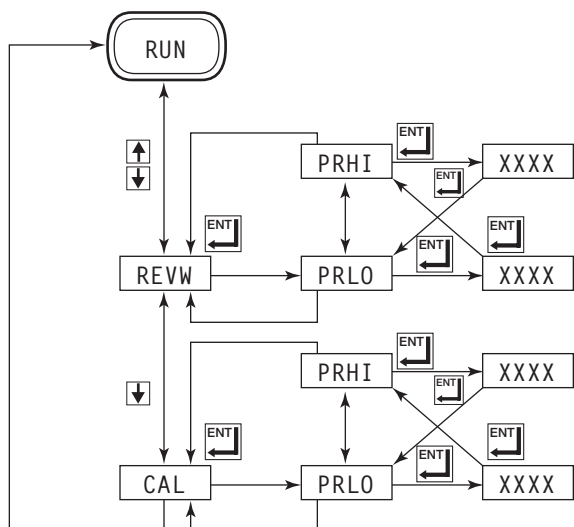

STEP 1: REVW (Review)

This menu allows the review of any previously stored PRL0/PRHI points. If this is the first time calibration is performed, proceed to Step 2.

1. To enter this menu from the RUN mode, press the UP and DOWN arrow keys simultaneously. () The display will read REVW (review).
2. Press ENT to display PRL0 (probe low).
3. Press ENT to display the previously stored PRL0 point.
4. Press ENT to display PRHI.
5. Press ENT to display the previously stored PRHI point.
6. Press ENT to display PRL0.
7. Press the DOWN arrow to return to the main path. The display will read CAL.



NOTE: If re-entering new PRL0/PRHI points for better accuracy, be sure that the new PRL0 point is lower than the existing PRL0 point and the new PRHI point is higher than the existing PRHI point.

STEP 2: CAL (Calibrate)



This menu allows the calibration of the Probe.

Caution: This is the most critical section of the calibration procedure. Before pressing ENT to enter data into the PRL0 or PRHI areas, be sure it is the proper area needed at that point. If an improper area is entered, pressing all three buttons simultaneously will return you to the RUN mode.

1. To enter this menu, press ENT . The display will read PRL0 (probe low).



-
2. If the PRL0 point is to be calibrated, press ENT  to display the present value.
 3. Use the UP  arrow key to scroll to the exact level of the media, in any unit of measurement (inches, feet, percentage, etc.), being consistent to use the same unit of measurement throughout the procedure.
 4. Once the exact unit is reached on the display, press ENT  to store the information in memory. The display will read PRHI (probe high). Raise the process level to a PRHI calibration point.



NOTE: If entering different PRL0/PRHI points for greater accuracy, be sure that the new PRL0 point is lower than the existing PRL0 point and the new PRHI point is higher than the existing PRHI point.

5. Press ENT  to display the present value. Scroll to the exact level of the media and press ENT  to store the information in memory. The display will read PRL0 once again.
6. Press the UP  arrow key to leave the CAL mode and return to the RUN mode, MAGNETROL INTL M M M.







Probe calibration is complete. Proceed to *Section 2.4.3, Program Path 4 — Multi-Point.*





2.4.2.1 Probe Calibration Tips

If you mistakenly get into the wrong area of the program (for instance, PRL0 data when PRHI data was intended), remember, pressing all the three tactile feedback keys (ENT/UP/DOWN    arrows) simultaneously will return you to the RUN mode.

After establishing the probe low point (and the unit times out from the CAL mode to the RUN mode while raising the level for the probe high point), DO NOT press ENT  after returning to the CAL mode when PRL0 appears. Press the UP  arrow key to bypass PRL0 and obtain PRHI. This will avoid setting the PRL0 point where the PRHI point should be.

If you get lost, and the unit continually displays ERROR messages (2LO or 2HI, etc.), do the following:

1. Return to the RUN mode by pressing the DOWN  arrow (from PRL0) or the UP  arrow (from PRHI).
2. From the RUN mode, press the ENT  and the UP  arrow keys simultaneously ( ) to enter the menu. The display will read CNFG.

3. Press the DOWN  arrow key to get to MODE. Press ENT .
4. Scroll to SING. Press ENT . Unit reads NOT READY. You are now in the Single Point Mode.
5. Return to CNFG and repeat the above procedure now choose MULT from the MODE menu. Press ENT . Unit reads MAGNETROL INTL M M M....
6. All of the original data has now been cleared.
7. Begin *Probe Calibration* procedure again from the start of *Program Path 3* (page 17).

2.4.2.2 Error Messages in PRLO/HI Menus

1. **2BIG:** Occurs during PRLO or PRHI data entry when displayed value exceeds 19999.
2. **2SML:** Occurs during PRLO data entry when displayed value underflows 0, or during PRHI when displayed value underflows 1.
3. **2 LO:** Occurs when stored PRHI measurement (not display) would be less than currently stored PRLO measurement. In other words, the capacitance being used to set the PRHI point is less than the capacitance used to set the PRLO.
4. **2 HI:** Occurs when stored PRLO measurement (not display) would be more than currently stored PRHI measurement. In other words, the capacitance being used to set the PRLO point is more than the capacitance used to set the PRHI point.
5. **UNDR:** Occurs when displayed value goes below -999.
6. **OVER:** Occurs when displayed value goes above 19,999 (red, >10,000 LED illuminated and 9999 on the display).

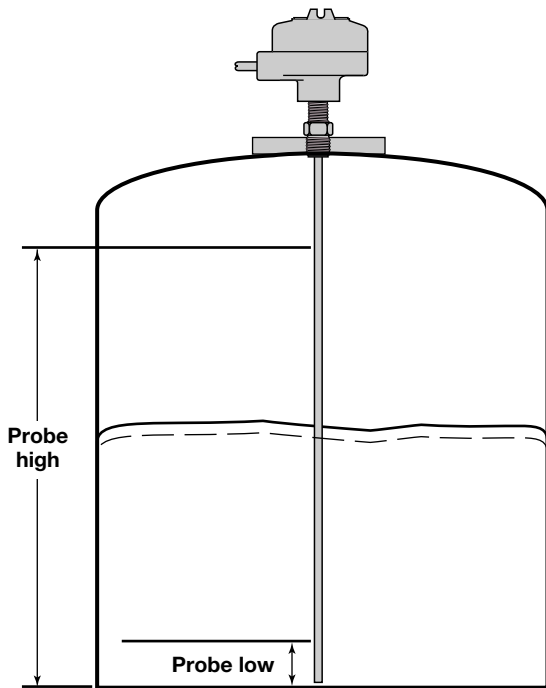
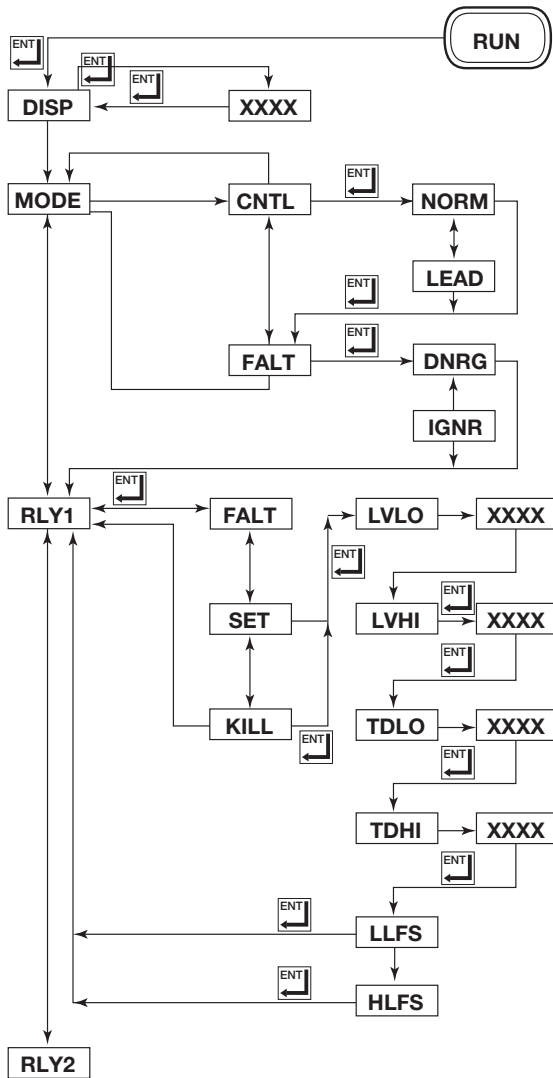

Figure 14

2.4.3 Program Path 4 — Multi-Point

The following procedure must be followed if MULT (multi-point) has been selected in Program Path 1 CNFG (configuration). Probe calibration, Program Path 2, must also be accomplished for the Multi-Point program to operate. These two procedures, Multi-Point and Probe Calibration, can be done in any order.



NOTE: Use the same unit of measure that was used in Probe Calibration. Be consistent throughout the program.

Press ENT to read DISP. Press the DOWN arrow key to display MODE.

STEP 1: DISP (Display)

1. Press ENT to read DISP. The display will read the actual process level, based on the unit of measure that was used in Probe Calibration (PRLO/PRHI).
2. Press the DOWN arrow key to display MODE.

STEP 2: MODE (Mode)

1. MODE refers to the configuration of both the control mode and the fault mode. Press ENT to display CNTL (control). Control allows for selection of normal or lead-lag pump control.
2. If this is the desired condition, press ENT .
3. The next level of the menu will be displayed; the selection of normal or lead-lag pump control. Choosing NORM will allow normal operation of the relays. If lead-lag pump sequencing is desired, press the DOWN arrow key to display LEAD.







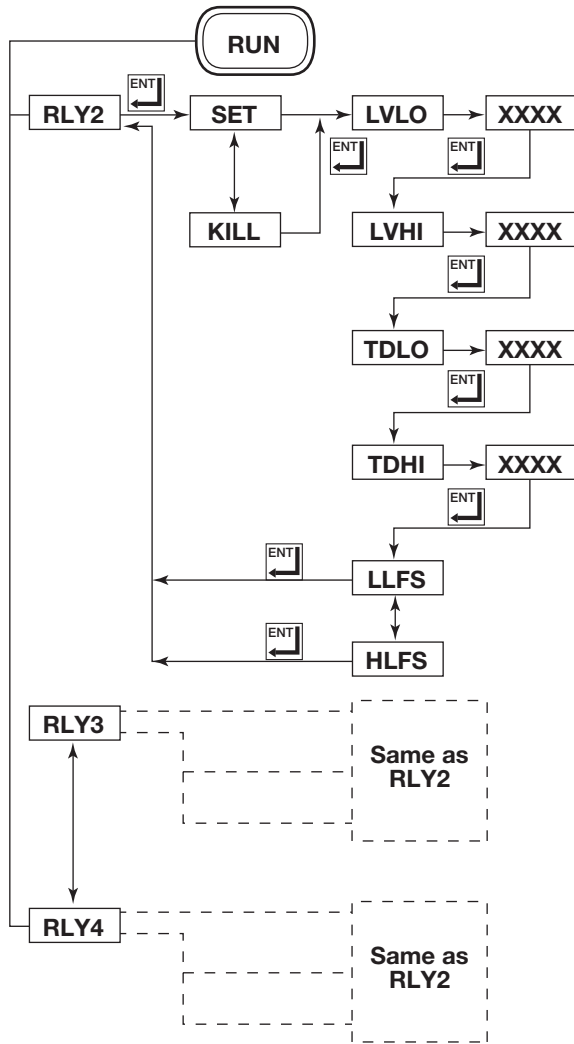

NOTE: Selection of LEAD (lead-lag) affects relays 2 and 3 only and does not apply to Model 822. LEAD must NOT be selected for Model 822.

4. Once the proper choice is displayed, press ENT to display FALT.
5. Press ENT to display DNRG (de-energize). In this position, all control relays will de-energize (go to a fail-safe state) when a fault is diagnosed.
6. Use the UP or DOWN arrow keys to toggle between DNRG (de-energize) or IGNR (ignore). If IGNR is chosen, all control relays will continue operating when a fault is diagnosed.
7. Press ENT to store the appropriate choice. The unit reads RLY1.

STEP 3: RLY1 (Relay 1)





1. With RLY1 displayed, press ENT to display FALT. In this setting, the RLY1 is used as a dedicated, diagnostic alarm. No other relay parameters (i.e., LVLO, TDHI) are offered. The relay will now de-energize when a diagnostic problem is encountered.
2. For other choices, use the DOWN arrow key to toggle to KILL. In this setting, the relay is removed from service. The process level may be varied (the display and the yellow LEDs will respond), but the relay will not change state and affect equipment (pump, valve, etc.) which is connected to it. The relay will remain in a de-energized state.
3. For the standard operating position, press the UP or DOWN arrow keys to display SET. Relays will respond to calibrated settings. (All relay parameters can be entered from either KILL or SET).
4. When the desired setting is displayed, press ENT to lock in the value and to display LVLO (low trip point).
5. Press ENT to display the current value.
6. Use the UP or DOWN arrow key to raise or lower the value.
7. When the desired setting is displayed, press ENT to lock in the value and display LVHI.
8. Press ENT once again to display the current value for LVHI (high trip point).
9. Use the UP or DOWN arrow key to raise or lower the value.
10. When the desired setting is displayed, press ENT to lock in the value and display TDLO (time delay low).
11. Press ENT once again to display the current value for TDLO. Time delay low selects the desired value of time delay on falling level.
12. Use the UP or DOWN arrow key to raise or lower the value. Time delay is adjustable between 0 and 90 seconds.
13. When the desired value is displayed, press ENT to lock in the value and to display TDHI (time delay high).
14. Press ENT once again to display the current value of TDHI. Time delay high selects the desired value of time delay on rising level.

15. Use the UP  or DOWN  arrow key to raise or lower the value. Time delay is adjustable between 0 and 90 seconds.
16. When the desired value is displayed, press ENT  to lock in the value and to display LLFS (low level fail-safe).
17. If LLFS is the required condition, press ENT  to display RLY1.
18. If high level fail-safe is desired, use the UP  or DOWN  arrow key to toggle to HLFS. When the desired condition is displayed, press ENT  to display RLY1. Refer to *Section 1.7.3, Relay Wiring Chart* for fail-safe information.
19. Press DOWN  arrow key to proceed to RLY2.

NOTE: If relay is used as an alarm, and differential is set to zero (i.e., LVLO = 14 and LVHI = 14), a small amount of time delay is recommended (usually one second).





NOTE: Relays 2, 3, and 4 are configured in the same manner as Relay 1, except that the fault condition is not an option.

2.4.4 Program Path 5 — Service

From the RUN display, press the ENT  and DOWN  arrow keys simultaneously.

The Service program path is designed to aid the customer in troubleshooting the Sentinel; it should be accessed only with the assistance from Magnetrol factory personnel. Only the TEST mode section may be utilized without factory assistance.

STEP 1: SRVC (Service)

From the RUN Mode, press the ENT  and DOWN  arrow keys simultaneously. ( ) The display will read SRVC.

STEP 2: VERS (Version)

Press ENT  to display VERS (version).

Press ENT  again to display the current software revision number.

Press ENT  to display SRVC once again.

Press ENT  to display VERS.

Use the DOWN  arrow key to display HEX (hexadecimal).

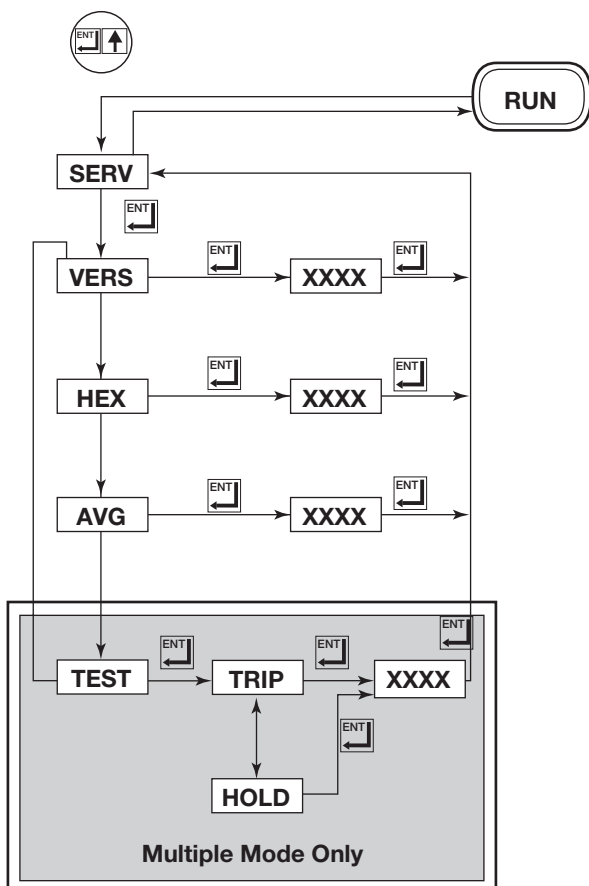

STEP 3: HEX (Hexadecimal)

Press ENT . Display will show a hexadecimal number related to capacitance in 0.25 pF increments.

Press ENT  to exit HEX and return to SRVC.

Press ENT  again to display VERS.

Using the DOWN  arrow key, press two times to display AVG.

STEP 4: AVG (Average)

Press ENT  to display a number (0–5) related to the amount of averaging of the probe signal the microprocessor does to yield a level value. A value of 0 is the minimum averaging value; 5 is the maximum averaging value. All units are shipped from the factory with a preset averaging value of 3.

NOTE: Consult factory before changing this value.

Press ENT , with the averaging value displayed, to return to SRVC.



Press ENT  again to display VERS.

Using the DOWN  arrow key, press it three times to display TEST.

STEP 5: TEST (Test)

The test mode allows manual scrolling of the process level via the keypad and LED display. This checks all relay settings artificially.

Press ENT  to display TRIP. Relays will change state (trip) at the calibrated points.

Use the UP  or DOWN  arrow keys to toggle to HOLD. In this setting, relays will not change state (hold) at the selected points, but the yellow LEDs will still signal as normal (OFF when below lowest differential point; blinking when inside differential; and ON when above highest differential point).

Press ENT  to display the present level.

Use the UP  arrow key to scroll through values.

ENT  will escape TEST and display SRVC.

With SRVC displayed, press the UP  arrow key to return to RUN.

NOTES:

1. The TEST mode will not operate until PRL0 and PRHI values are entered in Probe Calibration (Program Path 3).
2. There is no TEST mode for the single point program.

2.5 Advanced Calibration

Use these procedures in conjunction with standard calibration procedures already observed.

2.5.1 Calibration with No Level Change

1. **Single Point:** Accomplished in *Section 2.3.2, Program Path 2 — Single Point* procedure.

2.5.2 Tank Commissioning

Initial calibration in water (conductive medium) with final use in a non-conductive medium. If final medium is also conductive, no calibration change is necessary

2.5.2.1 Single Point

1. Water (commissioning medium): Follow standard calibration procedure.
2. Final Process Medium (non-conductive): In *Single Point* program, change MDIA (media) from COND (conductive) to NONC (non-conductive)

2.5.2.2 Multi-Point

NOTE: Proper probe choice is critical. If final medium is conductive (i.e., dielectric is >10 or conductivity is >10 micro mho/cm), any insulated probe may be utilized. If final medium is non-conductive (i.e., dielectric is <10 or conductivity is <10 micro mho/cm), an insulated stilling well probe must be utilized (models 8XA-XAXB-XXX or 8XB-AAXB-XXX).

1. **Water**
 - a. Establish PRL0 point (refer to *Section 2.4.2, Program Path 3 – Probe Calibration*). With probe installed and **NO** liquid in the vessel, enter PRL0 point. This value should equal the distance of the tip of the probe from the bottom of the vessel, plus one inch.
 - b. Establish PRHI point (refer to *Section 2.4.2, Program Path 3 – Probe Calibration*). Raise level of the commissioning liquid (usually water) to the highest point possible. Enter PRHI point.
 - c. Complete relay calibration (refer to *Section 2.4.2, Program Path 3 – Probe Calibration*).

2. **Final Process Medium**

With commissioning liquid removed and final process medium in the vessel, reestablish PRHI point (for best results at least 25% of the probe should be immersed). Relay control parameters are now calibrated to the new process medium.

3.0 Reference Information

3.1 Troubleshooting

3.1.1 Error Message Codes

The following error messages are displayed to aid the user in troubleshooting the system. Many of the error messages relate to data stored in the non-volatile memory. Error messages 11, 12, 13, and 16 can be investigated by the user. Consult factory for all other failures.



Symptom	Problem	Solution
Error Message 1 (ER1)	Relay 1: Error in stored data	Consult factory.
Error Message 2 (ER2)	Relay 2: Error in stored data	Consult factory.
Error Message 3 (ER3)	Relay 3: Error in stored data	Consult factory.
Error Message 4 (ER4)	Relay 4: Error in stored data	Consult factory.
Error Message 5 (ER5)	Relay configuration: lead-lag, Fail-safe	Consult factory.
Error Message 6 (ER6)	Average/filtering	Consult factory.
Error Message 7 (ER7)	Probe Hi/Probe Lo calibration error	Consult factory.
Error Message 8 (ER8)	Computation error based on E7	Consult factory.
Error Message 9 (ER9)	Parameter error in power up	Consult factory.
Error Message 10 (ER10)	Not applicable	Not Applicable.
Error Message 11 (ER11)	Preamplifier Test	Integral: consult factory. Remote: measure current on the positive (+) side of circuit, between preamplifier and main amplifier; 30 to 40 mA is proper.
Error Message 12 (ER12)	Probe Short Test	Disconnect the probe wire from the probe. Measure the resistance between the probe connection screw and the metal probe mounting nut; use the highest resistance scale available. A reading of 10 megohm or greater (and stable) is proper. NOTE: If the application is an insulated probe in a conductive medium, it helps to have the process level at the highest point possible. This aids in checking for nick or cuts in the probe insulation.
Error Message 13 (ER13)	Open probe circuit	Check wiring between electronics and probe.
Error Message 16 (ER16)	Immeasurable signal – No wave form beyond maximum capacitance capability.	Integral: Consult factory. Remote: Perform checks described under Error Messages 11, 12, and 13.
Display reads “NOT READY”	PR L0/PR HI points not calibrated	Calibrate probe Program Path 3 Calibration
The LED display defaults to Magnetrol Intl when a relay trips.	Noise from relay (and related equipment) is causing problems with microprocessor.	Install filtering device (i.e., MOVs) across relay terminals and supply voltage input.
The S or M stops walking across LED display, yet no error message appears.	The 8-pin header between the two circuit boards is not making good contact.	Consult factory.
Error messages 11, 12, 16	AC/DC DC Probe totally shorted. Supply power between 19-21 VDC	Review solution for ER 12. Check supply power.
Diagnostic relay trips every time the process level trips the alarm relay (Single Point program only).	Process medium is conductive, but non-conductive was chosen in step 2 of Single Point program.	Recalibrate steps 2 and 3 of Single Point program with accurate information.
Display reads UNDR.	Numbers have exceeded lower limit of negative 999, usually caused by PRL0/PRHI points being entered extremely close to (or on top of) one another.	Recalibrate PRL0/PRHI points.
Display reads OVER.	Numbers have exceeded upper limit of 19,999, usually caused by PRL0/PRHI points being entered extremely close to (or on top of) one another.	Recalibrate PRL0/PRHI points.
No fail-safe choice offered for RLY 3	LEAD is chosen in Mode/Control, yielding a lead-lag function.	This is a normal condition for the lead-lag function.

3.2 Specifications

3.2.1 Electrical

Supply voltage	120 VAC, 50/60 Hz (+10/-15%) 240 VAC, 50/60 Hz (+10/-15%) 24 VDC ($\pm 10\%$)
Power consumption	15 VA nominal
Humidity	99% non-condensing (electronics)
Electrostatic discharge protection	Per IEC specification 801-2
Response time	70 ms to approximately 2 seconds, depending upon probe capacitance and averaging value
Ambient temperature	-40° F to +160° F (-40° to +70° C)
Temperature coefficient of set point	$\pm 0.01\%$ /degree F ($\pm 0.018\%$ /degree C)
Maximum remote mount distance	Standard 2500 feet (760 m) Intrinsically safe 800 feet (240 m)
Data	Entry 3-button keypad Indication 4-digit LED, 1 overflow LED for +10,000
Relays 2 to 4 DPDT	AC 10 amp @ 120/240 VAC resistive DC 10 amp @ 30 VDC resistive, 0.5 amp @ 125 VDC resistive
Set point range	0–50,000 pF
Differential range	0.50 pF minimum / 50,000 pF maximum
Time delay	0–90 seconds level rising, falling, both

3.3 Agency Approvals

Agency	Approved Model	Protection Method	Area Classification
FM 	8X2-1X02-G0X 8X2-1X03-G0X with rigid insulated probe	Explosion proof	Class I Div. 1, Groups C & D Class II Div. 1, Groups E, F & G NEMA 4X, IP65
	8X2-1X05-G0X 8X2-1X06-G0X	Explosion proof with intrinsically safe probe circuit	Electronics: Class I Div. 1, Groups C & D Class II Div. 1, Groups E, F & G NEMA 4X, IP65 Probe: Class I, II, III, Div. 1, Groups A, B, C, D, E, F & G NEMA 4X, IP65
	8X2-1X02-R0X 8X2-1X03-R0X 8X2-1X03-Y0X with rigid insulated probe	Explosion proof	Class I Div. 1, Groups B, C & D Class II Div. 1, Groups E, F & G NEMA 4X, IP65
	8X2-1X05-R0X 8X2-1X06-R0X 8X2-1X06-Y0X	Explosion proof with intrinsically safe probe circuit	Electronics: Class I, Div. 1, Groups B, C & D Class II, Div. 1, Groups E, F & G NEMA 4X, IP65 Probe: Class I, II, III, Div. 1, Groups A, B, C, D, E, F & G NEMA 4X, IP65
CSA 	8X2-1X00-C00 8X2-1X01-C00	Non-hazardous	TYPE 4X
	8X2-1X02-G0X 8X2-1X03-G0X with rigid insulated probe	Explosion proof	Class I Div. 1, Groups C & D Class II Div. 1, Groups E, F & G TYPE 4X
	8X2-1X05-G0X 8X2-1X06-G0X	Explosion proof with intrinsically safe probe circuit	Electronics: Class I Div. 1, Groups C & D Class II Div. 1, Groups E, F, G TYPE 4X Probe: Class I, II, III, Div. 1, Groups A, B, C, D, E, F & G TYPE 4X
	8X2-1X02-R0X 8X2-1X03-R0X 8X2-1X03-Y0X with rigid insulated probe	Explosion proof	Class I Div. 1, Groups B, C & D Class II Div. 1, Groups E, F & G TYPE 4X
	8X2-1XX5-R0X 8X2-1XX6-R0X 8X2-1XX6-Y0X	Explosion proof with intrinsically safe probe circuit	Electronics: Class I Div. 1, Groups B, C & D Class II Div. 1, Groups E, F, G TYPE 4X Probe: Class I, II, III, Div. 1, Groups A, B, C, D, E, F & G TYPE 4X

3.4 Intrinsic Safety

THIS DRAWING IS THE EXCLUSIVE PROPERTY OF MAGNETROL INTERNATIONAL. NO PART OF THIS DRAWING IS TO BE REPRODUCED OR TRANSMITTED IN ANY FORM OR BY ANY MEANS, ELECTRONIC OR MECHANICAL, INCLUDING PHOTOCOPYING, RECORDING, OR BY ANY INFORMATION STORAGE AND RETRIEVAL SYSTEM, WITHOUT THE EXPRESS WRITTEN PERMISSION OF MAGNETROL INTERNATIONAL.

THIRD ANGLE PROJECTION

IN IN (mm)

HAZARDOUS LOCATION

INTRINSICALLY SAFE FOR CLASS I, DIV 1, GROUPS A, B, C, & D, CLASS II, DIV. 1, GROUPS E, F, & G, CLASS III

HAZARDOUS LOCATION

EXPLOSION PROOF FOR CLASS I, DIV. 1, GROUPS B, C & D, DUST IGNITION PROOF FOR CLASS II, DIV. 1, GROUPS E, F, & G, CLASS III FOR 8X2-XX06-GDX - GROUPS C & D ONLY

CONTROLLER/TRANSMITTER

MAGNETROL MODELS
8X2-XX05 G
6 Y

INTRINSIC SAFETY GROUND

INSTRUMENT PROBE OUTPUT TERMINALS

NOTES:

1. THE NEC MUST BE FOLLOWED WHEN INSTALLING THIS EQUIPMENT.
2. FOR INSTALLATION GUIDANCE, SEE ANSI/ISA RP 12.6.
3. THE RESISTANCE BETWEEN THE ASSOCIATED APPARATUS INTRINSIC SAFETY GROUND TERMINAL AND EARTH MUST BE LESS THAN ONE OHM.
4. NON-HAZARDOUS AREA EQUIPMENT CONNECTED TO THE ASSOCIATED APPARATUS SHOULD NOT USE OR GENERATE MORE THAN 250 VOLTS.
5. THE TOTAL CABLE SERIES INDUCTANCE AND SHUNT CAPACITANCE BETWEEN THE ASSOCIATED APPARATUS AND THE REMOTE PROBE MUST NOT EXCEED THE INDICATED VALUES FOR APPLICABLE GROUPS:

GROUP	MAX. CAPACITANCE	MAX. INDUCTANCE
AB	0.13µF	0.47 mH
CE	0.92µF	1.97 mH
DFG	2.89µF	3.53 mH

6. NO REVISIONS SHALL BE MADE TO THIS DRAWING WITHOUT FM OR CSA AUTHORIZATION.
7. FOR CSA CERTIFICATION, INSTALLATION SHALL BE AS SPECIFIED BY CANADIAN ELECTRIC CODE.

AGENCY LISTED DRAWING

ALL REVISIONS TO THIS DRAWING REQUIRE QA APPROVAL

MATERIAL	UNLESS OTHERWISE SPECIFIED: TITLE
RAW MAIL PART NO.	PLAIN DIMENSIONS IN INCHES: 0 OR 1/16" DIMENSIONS IN MILLIMETERS
HEAT TREAT	REMOVE ALL BURRS AND SHARP EDGES, MAX. ALLOWED .032(0.81)
FINISH	INSIDE RADIUS .032(0.81) R. DRAWN S. RADA DATE 3-18-93
	ALL FINISHES 125 ✓/GR BETTER
	TOLERANCES:
	2 PL. IN. DEC. ± 0.015 IN. (0.4mm)
	3 PL. IN. DEC. ± 0.005 IN. (0.2mm)
	ANGULAR ± 2'

SYMBOL	DESCRIPTION	BY & DATE	CHANGE NO.
H	SEE PG 1 FOR REVISIONS	JJ 6-97	3042-332

SYMBOL	DESCRIPTION	BY & DATE	CHANGE NO.

P/N 99-5043-002

99-5043

Magnetrol
5300 BELMONT ROAD, DOWNERS GROVE, ILLINOIS 60515 / AREA 708 / 969-4000

SYSTEM DRAWING
SENT INEL
E.P. SWITCH W.I.S. PROBE
CHKDUM JARAS JIR DATE 3-22-93
APFD TF HOFRICHTER DATE 5-18-93
PROJ NO. 3042-181 SKETCH NO.

SCALE 1:1
PAGE 2 OF 5
99-5043

3.4 Intrinsic Safety (cont.)

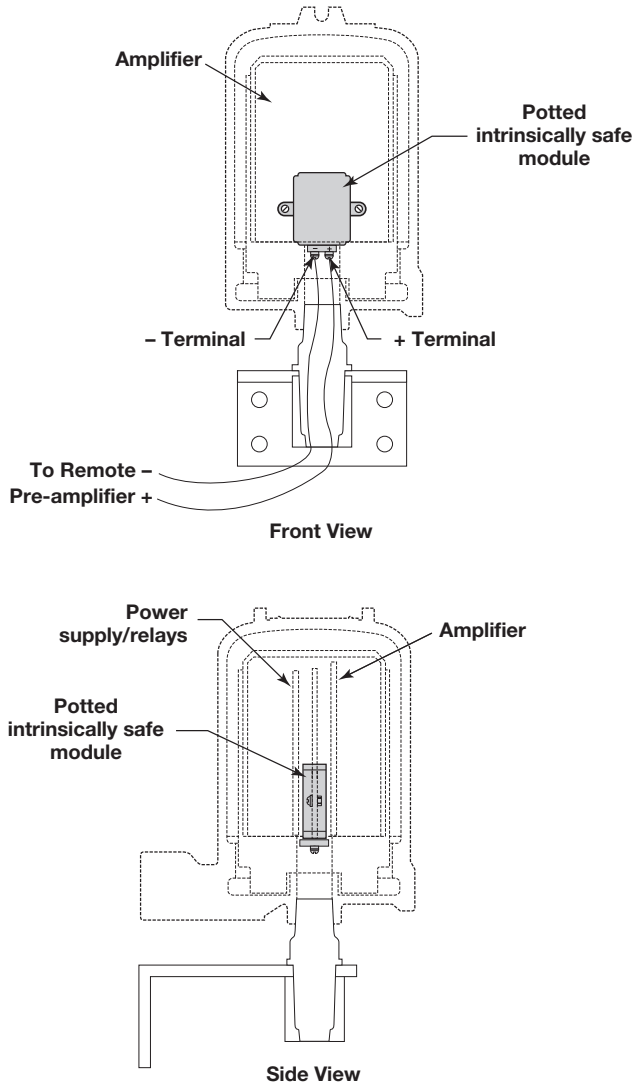

Figure 15

Model 8X2-1X06-G0X Remote Mount Intrinsically Safe Probe Circuit Explosion Proof Housing

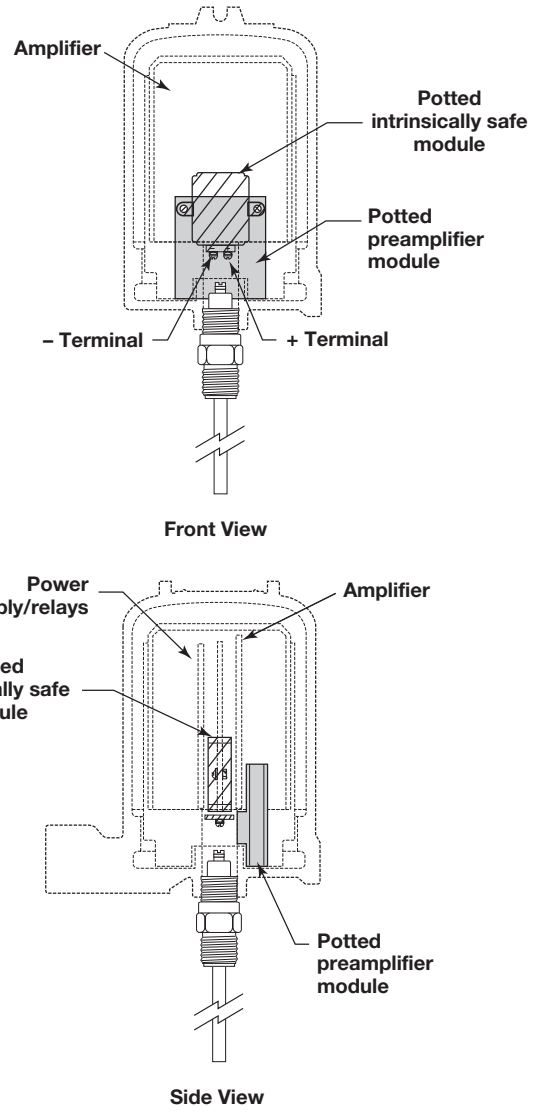

Figure 16

Model 8X2-1X05-G0X Integral Mount Intrinsically Safe Probe Circuit Explosion Proof Housing

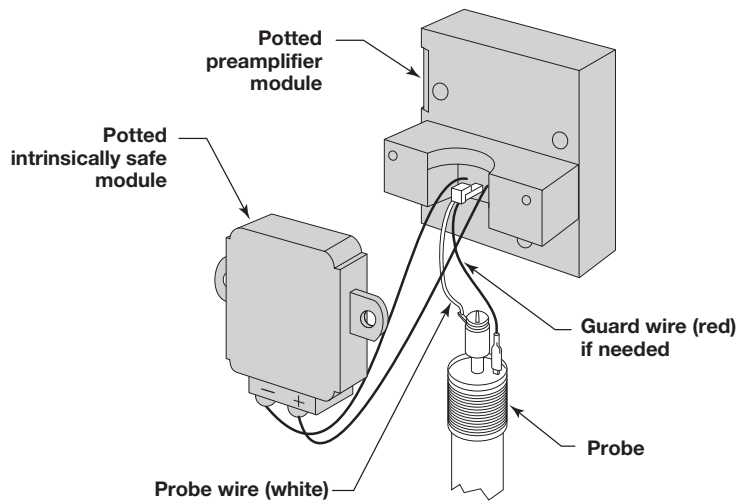

Figure 17

3.5 Specifications

3.5.1 Dimensional

inches (mm)

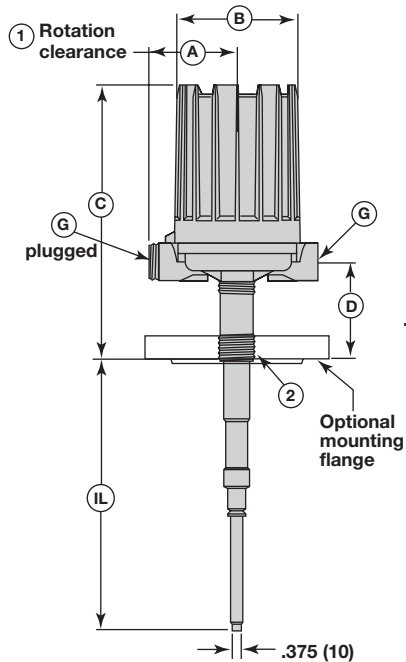

Figure 18

Integral Mount with Guarded Probe
(shown with Aluminum Housing)

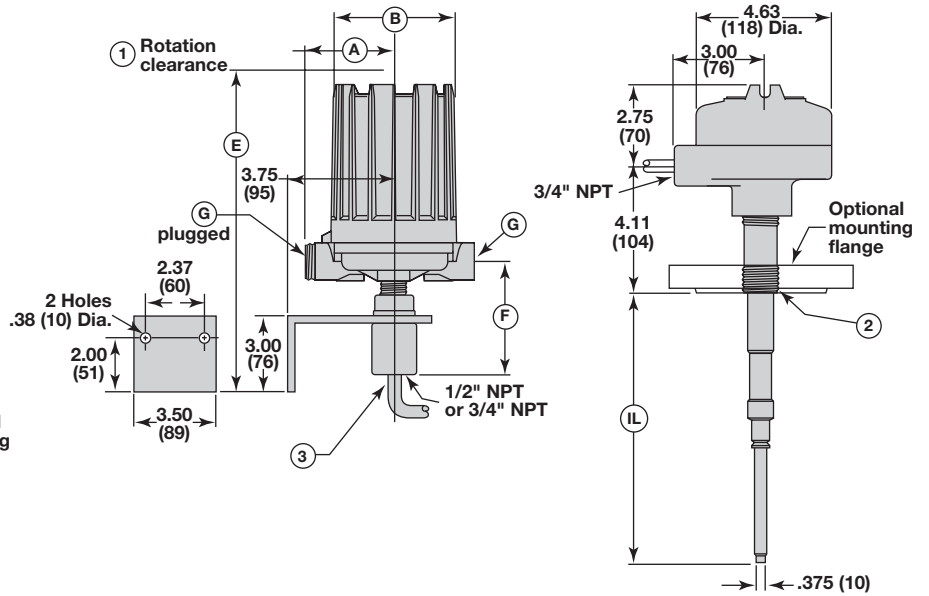

Figure 19

Remote Mount with Guarded Probe
(shown with Aluminum Housing)

Outline Dimensions														
Housing	A	B	Standard Rigid Probe				Flexible Probe				Guarded Probe			
			C	D	E	F	C	D	E	F	C	D	E	F
NEMA 4X Carbon steel	3.25 (82)	4.69 (119)	9.04 (230)	2.29 (58)	11.67 (296)	4.04 (103)	10.48 (266)	3.73 (95)	11.67 (296)	4.04 (103)	9.84 (250)	3.17 (80)	11.67 (296)	4.04 (103)
NEMA 4X/7/9 Cast iron	5.25 (133)	5.81 (148)	11.26 (286)	2.40 (61)	13.81 (351)	4.15 (105)	12.70 (323)	4.67 (119)	13.81 (351)	4.15 (105)	12.06 (306)	3.28 (83)	13.81 (351)	4.15 (105)
NEMA 4X/7/9 Aluminum	3.87 (98)	5.93 (151)	10.89 (276)	2.44 (61)	13.44 (341)	4.11 (104)	12.33 (313)	4.71 (119)	13.44 (341)	4.11 (104)	11.69 (296)	3.32 (84)	13.44 (341)	4.11 (104)

inches (mm)

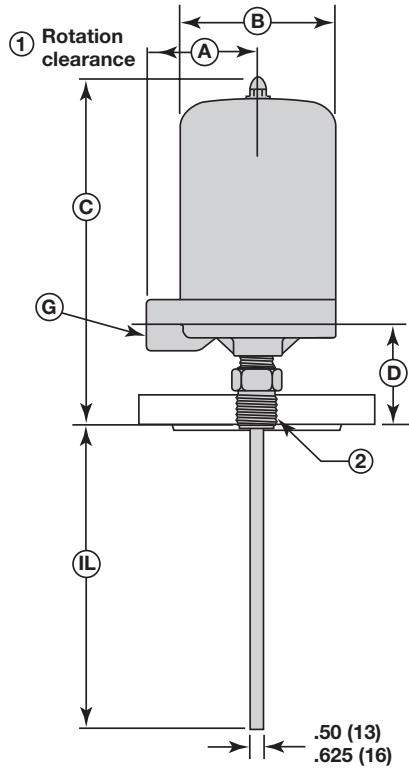

Figure 20
Integral Mount with Standard Rigid Probe
(shown with Carbon Steel Housing)

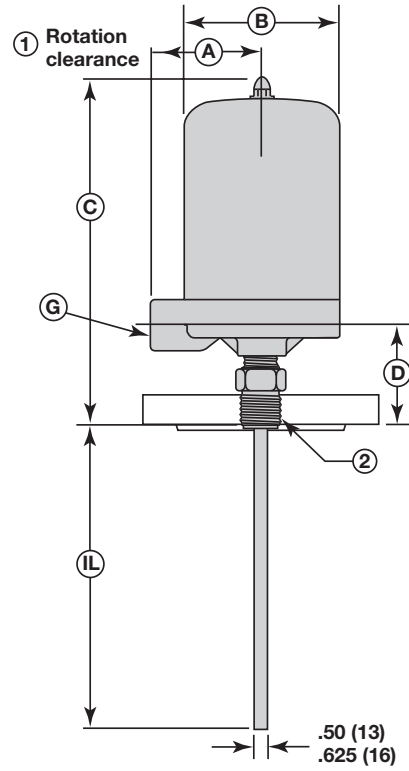

Figure 21
Integral Mount with Flexible Probe
(shown with Cast Iron Housing)

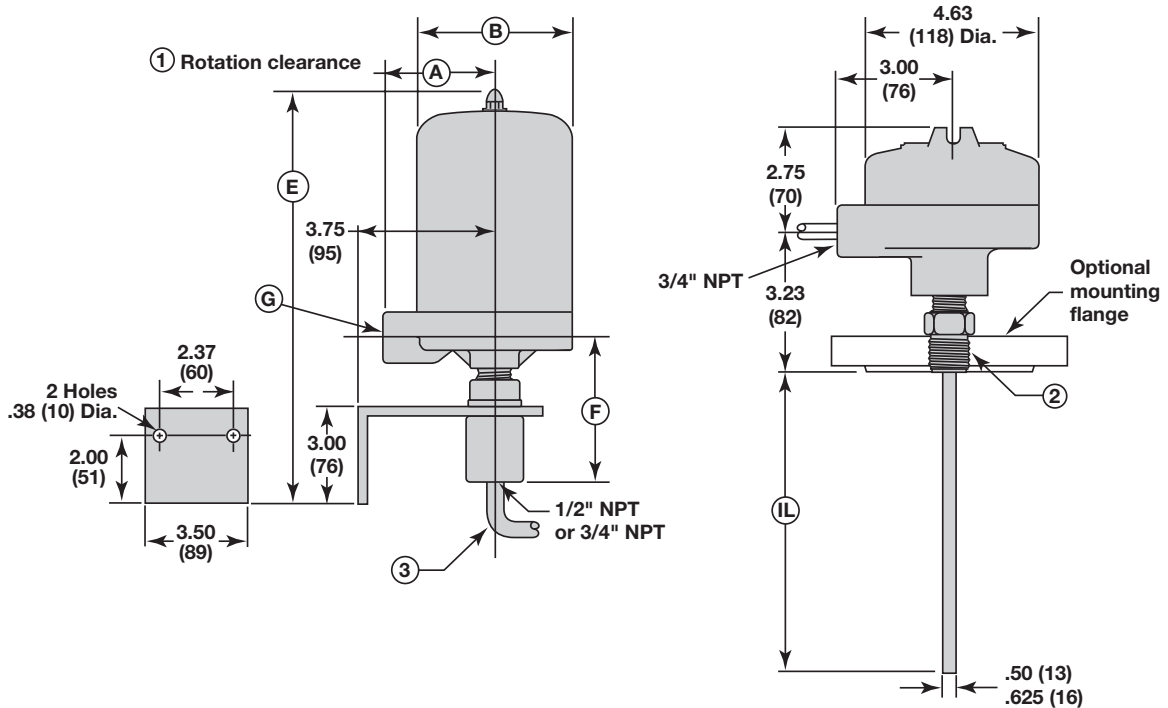

Figure 22
Remote Mount with Standard Rigid Probe
(shown with Carbon Steel Housing)

inches (mm)

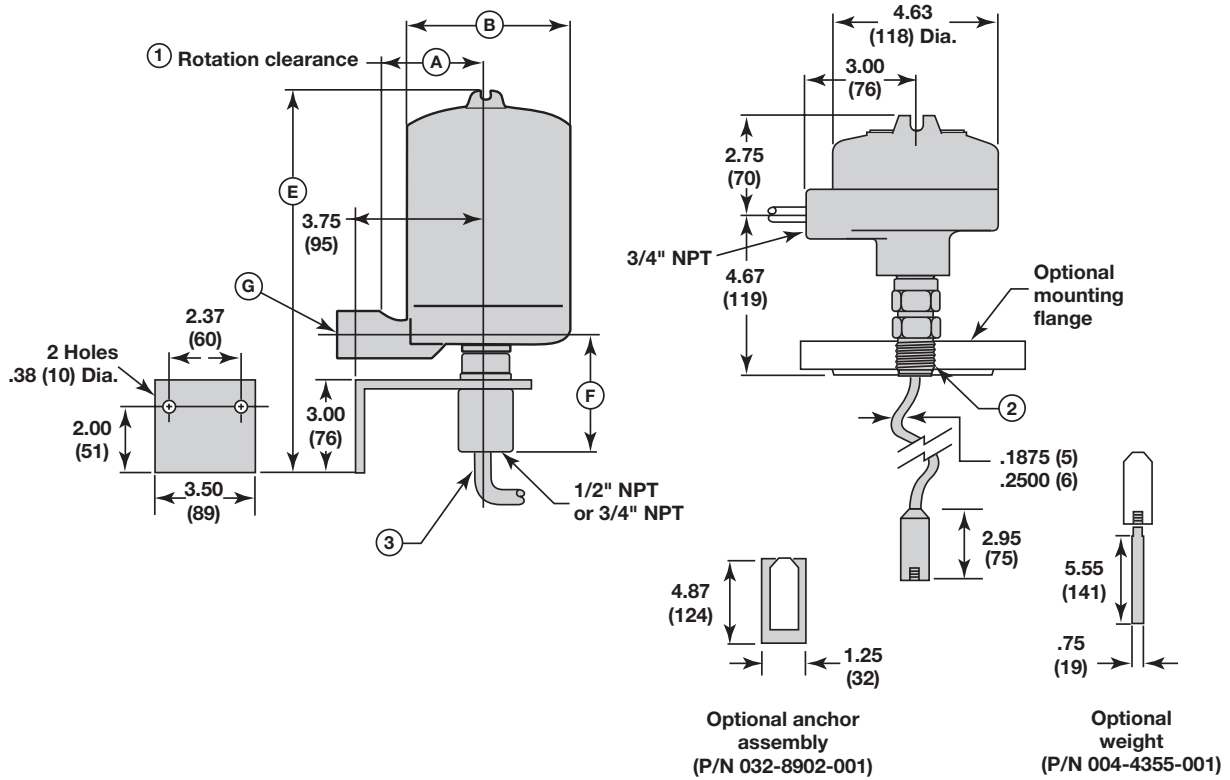

Figure 23
Remote Mount with Flexible Probe
(electronic shown with Cast Iron Housing)

Conduit Connections G	
NEMA 4X Single conduit	3/4" NPT
NEMA 4X/7/9 Single conduit	1" NPT
NEMA 4X/7/9 Dual conduit	1" NPT

NOTES:

- ① Allow 8 in. (203 mm) overhead clearance for cover removal.
- ② Standard process connection is 3/4" NPT. Consult probe brochure (50-125) for flange and other probe connections.
- ③ Probe/amplifier connecting cable to be shielded, twisted-pair, 22-gauge stranded conductors. Magnetrol P/N 009-7146-001 2500 feet (760 m); maximum 800 feet (240 m) maximum for intrinsically safe models.

3.6 Parts

3.6.1 Replacement

No.	Description	Part Number		
1	Amplifier	Non-hazardous	Z30-2409-001	
		Integral	Hazardous	Z30-2409-001
		I.S. circuitry	Z30-2410-001	
	PC board	Non-hazardous	Z30-2410-002	
		Remote	Hazardous	Z30-2410-002
	I.S. circuitry	Z30-2410-001		

Note: Refer to model number digit 7 for proper amplifier PC board

Power supply/relay board:				
	Model 822	Model 832	Model 842	
2	120 VAC	Z30-2407-001	Z30-2407-002	Z30-2407-003
	240 VAC	Z30-2407-004	Z30-2407-005	Z30-2407-006
	24 VDC	Z30-2407-007	Z30-2407-008	Z30-2407-009
Preamplifier board:				
3	A. Standard (remote)			Z30-2411-002
	B. Intrinsically safe, remote (potted module)			Z30-9005-001
	C. Intrinsically safe, integral (potted module)			Z30-9003-001
4	Intrinsically safe barrier (potted module)			Z30-9002-001
5	Housing cover	NEMA 4X Carbon steel	089-6523-001	
		NEMA 4X/7/9 Cast iron	089-6554-002	
		NEMA 4X/7/9 Aluminum	089-6554-003	
6	O-Ring	NEMA 4X	012-1318-001	
		NEMA 4X/7/9	012-2501-249	
7	Housing base	NEMA 4X Aluminum single conduit	004-9165-002	
		NEMA 4X/7/9 Cast iron, single conduit	004-9138-003	
		NEMA 4X/7/9 Aluminum dual conduit	004-9173-003	
8	Remote probe housing	Aluminum single conduit	089-6585-001	
		316 SS, single conduit	089-6585-002	
9	Remote electronics mounting bracket	1/2" NPT	036-3805-001	
		3/4" NPT	036-3805-003	
10	Connecting cable up to 2500 ft. (760 m) Intrinsically safe 800 ft. (240 m) (shielded, twisted pair, 22-gauge stranded conductors)			009-7146-001

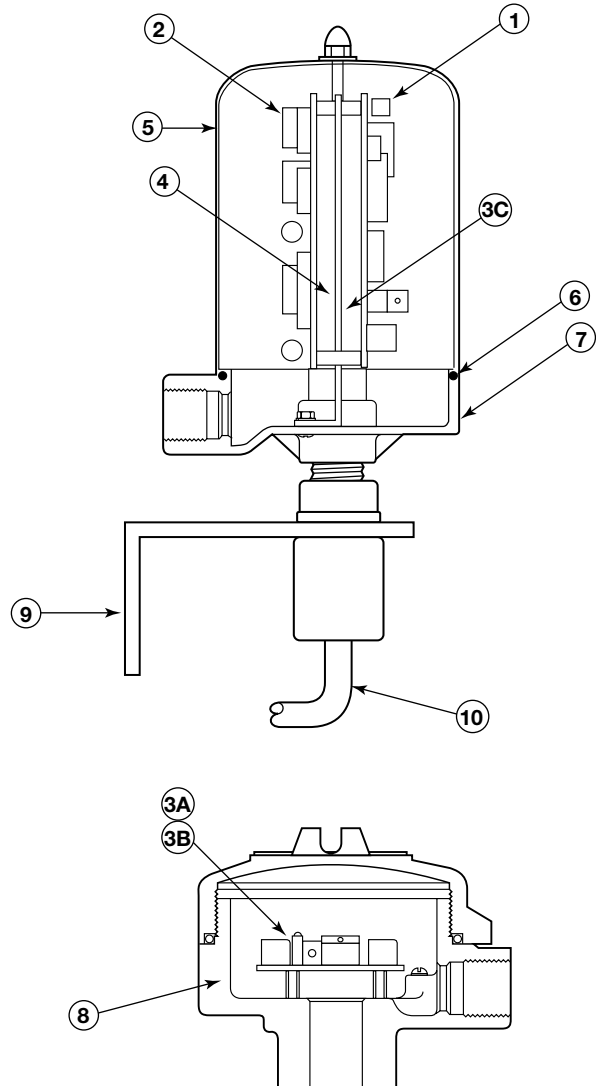

3.7 Model Numbers

RELAYS

2	Relays
3	3 Relays (lead/lag)
4	4 Relays (lead/lag)

INPUT POWER

0	120 VAC
1	240 VAC
2	24 VDC

MOUNTING

0	Integral NEMA 4X
1	Remote NEMA 4X
2	Integral NEMA 4X/7/9
3	Remote NEMA 4X/7/9
5	Integral NEMA 4X/7/9 w/intrinsically safe probe circuit
6	Remote NEMA 4X/7/9 w/intrinsically safe probe circuit

HOUSINGS

C	NEMA 4X, aluminum base with carbon steel cover, 3/4" NPT single conduit
G	NEMA 4X/7/9, cast iron, 1" NPT single conduit
R	NEMA 4X/7/9, aluminum, 1" NPT dual conduit
Y	NEMA 4X/7/9, aluminum, 1" NPT dual conduit with 316 SS 3/4" NPT single conduit (remote mount only)

PROBE SELECTION

0	Probe ordered separately
1	18" (457 mm) guarded probe)
2	36" (914 mm) guarded probe)

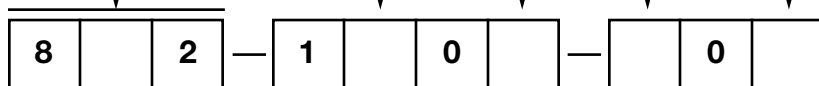

NOTES

NOTES

Service Policy

Owners of Magnetrol controls may request the return of a control or any part of a control for complete rebuilding or replacement. They will be rebuilt or replaced promptly. Controls returned under our service policy must be returned by Prepaid transportation. Magnetrol will repair or replace the control at no cost to the purchaser (or owner) other than transportation if:

1. Returned within the warranty period; and
2. The factory inspection finds the cause of the claim to be covered under the warranty.

If the trouble is the result of conditions beyond our control; or, is NOT covered by the warranty, there will be charges for labor and the parts required to rebuild or replace the equipment.

In some cases it may be expedient to ship replacement parts; or, in extreme cases a complete new control, to replace the original equipment before it is returned. If this is desired, notify the factory of both the model and serial numbers of the control to be replaced. In such cases, credit for the materials returned will be determined on the basis of the applicability of our warranty.

No claims for misapplication, labor, direct or consequential damage will be allowed.

Return Material Procedure

So that we may efficiently process any materials that are returned, it is essential that a "Return Material Authorization" (RMA) number be obtained from the factory, prior to the material's return. This is available through Magnetrol's local representative or by contacting the factory. Please supply the following information:

1. Company Name
2. Description of Material
3. Serial Number
4. Reason for Return
5. Application

Any unit that was used in a process must be properly cleaned in accordance with OSHA standards, before it is returned to the factory.

A Material Safety Data Sheet (MSDS) must accompany material that was used in any media.

All shipments returned to the factory must be by prepaid transportation.

All replacements will be shipped F.O.B. factory.

NOTE: See Electrostatic Discharge Handling Procedure on page 1.



5300 Belmont Road • Downers Grove, Illinois 60515-4499 • 630-969-4000 • Fax 630-969-9489 • www.magnetrol.com
 145 Jardin Drive, Units 1 & 2 • Concord, Ontario Canada L4K 1X7 • 905-738-9600 • Fax 905-738-1306
 Heikensstraat 6 • B 9240 Zele, Belgium • 052 45.11.11 • Fax 052 45.09.93
 Regent Business Ctr., Jubilee Rd. • Burgess Hill, Sussex RH15 9TL U.K. • 01444-871313 • Fax 01444-871317



5300 Belmont Road • Downers Grove, Illinois 60515-4499 • 630-969-4028 • Fax 630-969-9489 • www.sticontrols.com

Copyright © 2006 Magnetrol International, Incorporated. All rights reserved. Printed in the USA.

CSA logotype is a registered trademark of Canadian Standards Association
 Mylar® is a registered trademark of DuPont Teijin Films
 Teflon® is a registered trademark of DuPont Performance Elastomers

BULLETIN: 50-621.9
EFFECTIVE: September 2005
SUPERSEDES: July 2004